

SERVICE MANUAL

C-4 PRE-AMPLIFIER



004367

SINCE 1887



YAMAHA

NIPPON GAKKI CO., LTD. HAMAMATSU, JAPAN

Jun '78 2K T.T.  Printed in Japan

CONTENTS

PANEL OPERATION 2
 PACKAGE INSTRUCTION 4
 APPELLATION OF PARTS 5
 DISASSEMBLY PROCEDURES 6
 ADJUSTMENT/ADJUSTMENT POINTS 8
 BLOCK DIAGRAM/LEVEL DIAGRAM 9
 SPECIFICATIONS 10
 CIRCUIT BOARDS 11
 SCHEMATIC DIAGRAM 12

PANEL OPERATION

FRONT PANEL

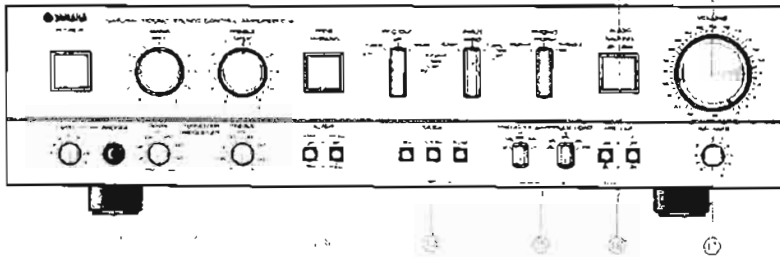

- 1 POWER Switch
- 2 BASS Control
- 3 TREBLE Control
- 4 TONE BYPASS Control
- 5 REC OUT Selector
- 6 INPUT Selector
- 7 PHONO Input Selector
- 8 AUDIO MUTING Switch
- 9 VOLUME Control
- 10 PHONES LEVEL Control
- 11 PHONES Jack
- 12 TURNOVER FREQUENCY Controls
- 13 FILTER Switches
- 14 MODE Switches
- 15 PHONO-1,2 CARTRIDGE LOAD Switches
- 16 PRE OUT Selectors
- 17 BALANCE Control

REAR PANEL

U.S.A and CANADIAN Model

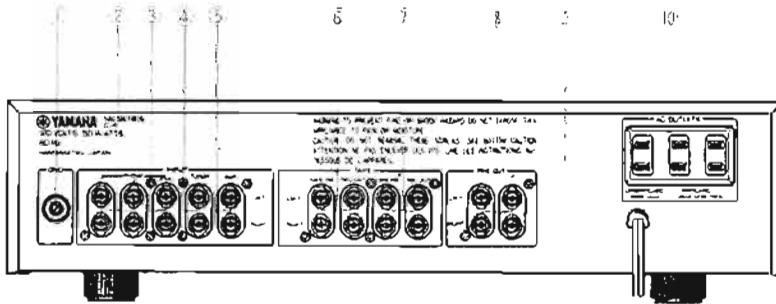

- 1 GND Terminal
- 2 PHONO-1,2(MM) Terminals
- 3 PHONO-3(MC) Terminals
- 4 TUNER Terminals
- 5 AUX Terminals
- 6 TAPE 1 PB and REC OUT Terminals
- 7 TAPE 2 PB and REC OUT Terminals
- 8 PRE OUT Terminals
- 9 AC Power Cord
- 10 AC OUTLETS

EUROPEAN and GENERAL Model

(General Model)

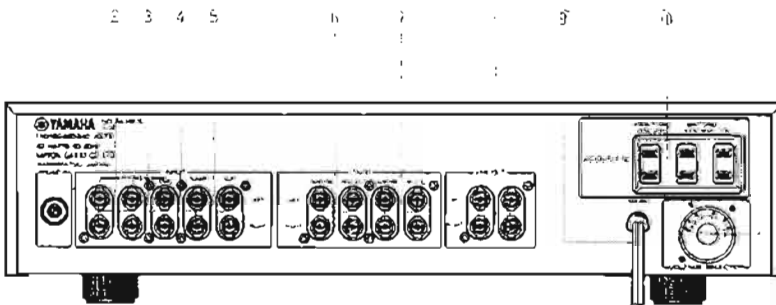

- 1 GND Terminal
- 2 PHONO-1,2(MM) Terminals
- 3 PHONO-3(MC) Terminals
- 4 TUNER Terminals
- 5 AUX Terminals
- 6 TAPE 1 PB and REC OUT Terminals
- 7 TAPE 2 PB and REC OUT Terminals
- 8 PRE OUT Terminals
- 9 AC Power Cord
- 10 AC OUTLETS (General model only)
- 11 VOLTAGE SELECTOR

NOth EUROPEAN , BRITISH and AUSTRALIAN Model

(Noth European Model)

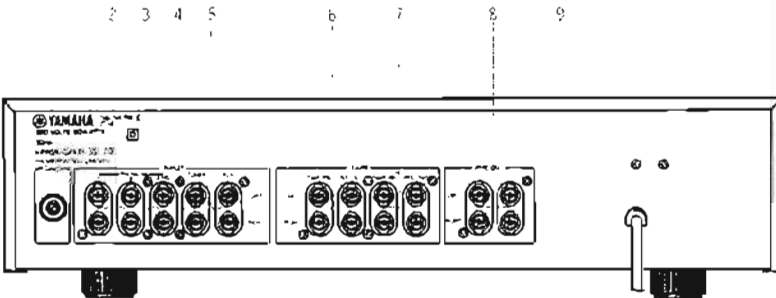

- 1 GND Terminal
- 2 PHONO-1,2(MM) Terminals
- 3 PHONO-3(MC) Terminals
- 4 TUNER Terminals
- 5 AUX Terminals
- 6 TAPE 1 PB and REC OUT Terminals
- 7 TAPE 2 PB and REC OUT Terminals
- 8 PRE OUT Terminals
- 9 AC Power Cord

■ PACKAGE INSTRUCTION

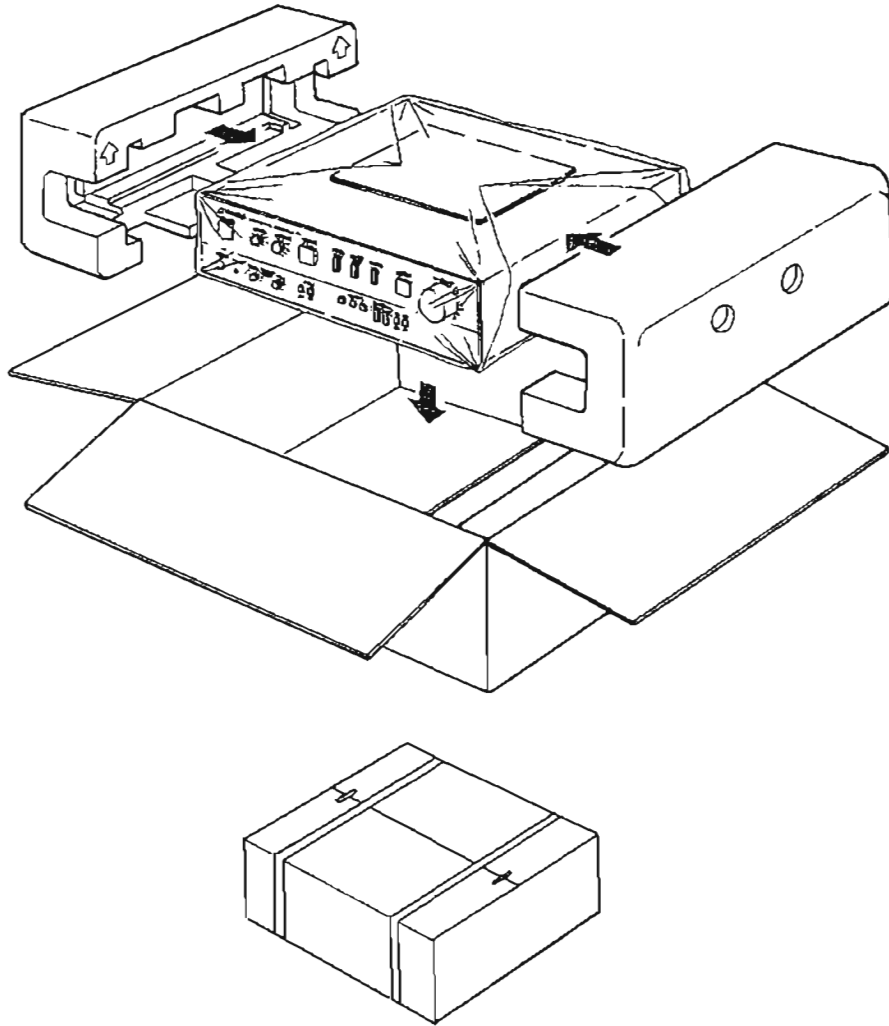

■ APPELLATION OF PARTS

INTERNAL APPEARANCE (Upper side)

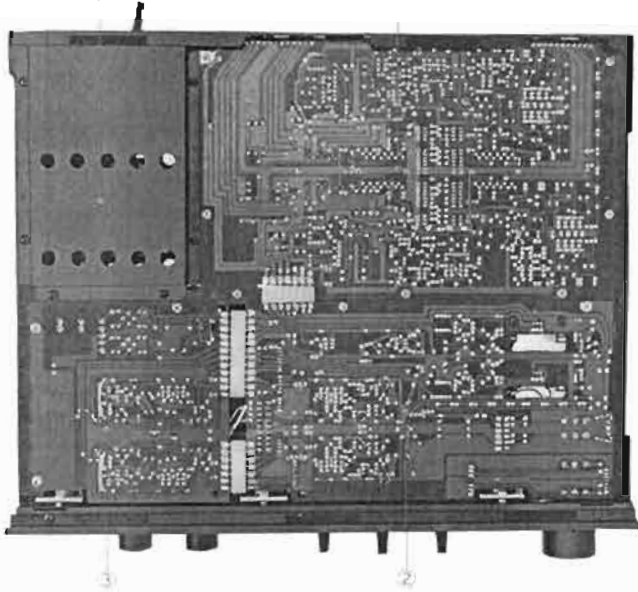

- 1 Function C Board
NA07149 (U:NA07150)
- 2 Flat Amp. C Board
NA07151 (U:NA07152)
- 3 Power C. Board
NA07153 (U:NA07154)
- 4 Transformer Shield

INTERNAL APPEARANCE (Bottom side)

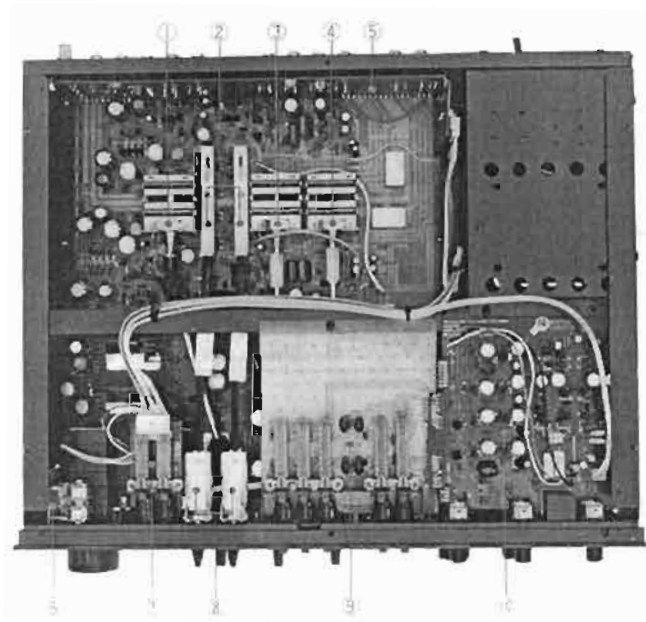

- 1 PHONO Input Selector Switch
- 2 PHONO-1,2 CARTRIDGE
LOAD Switches
- 3 INPUT Selector Switch
- 4 REC OUT Selector Switch
- 5 Pin Jack C. Board
NA07148
- 6 Flat Amp. C. Board (3)
NA07151-3 (U:NA07152-3)
- 7 Flat Amp. C. Board (2)
NA07151-2 (U:NA07152-2)
- 8 Remote Switches
- 9 Switch C. Board
NA07157 (U:NA07169)
- 10 Headphone C. Board
NA07155 (U:NA07156)

DISASSEMBLY PROCEDURES

1. Removal of Top Cover

After removing screws ①-④ shown in Photo 1, take off the top cover by drawing it toward the rear panel side.

2. Removal of Bottom Cover

Detach screws ⑤-⑩ shown in Photo 1.

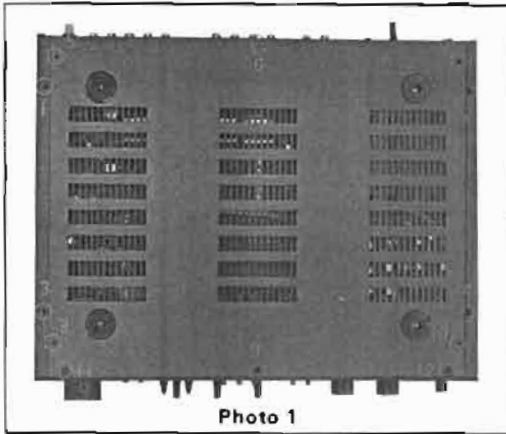

Photo 1

3. Removal of Front Panel

- (1) Take off both the top and bottom covers. (Refer to Steps 1 and 2.)
- (2) Pull out the PHONES-LEVEL knob and the BASS, TREBLE and BALANCE knobs of TURNOVER FREQUENCY toward yourself.
- (3) Using a hexagonal wrench (M1.5φ), unscrew the set screws of the BASS, TREBLE, REC OUT, INPUT, PHONO, VOLUME and PHONO-1, 2 CARTRIDGE LOAD knobs, and pull out the knobs.
- (4) Take off screws ⑪ and ⑫ (Photo 1) and screws ① and ② (Photo 2). Detach the front panel, drawing it gently toward yourself.
 - * When doing this, be careful not to damage the lead wires of the pilot lamps for the POWER, TONE BYPASS and AUDIO MUTING switches.
- (5) Pull out the pilot lamps of the POWER, TONE BYPASS and AUDIO MUTING switches from the lamp holders. (See Fig. 1.)

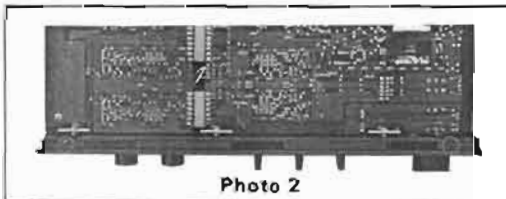

Photo 2

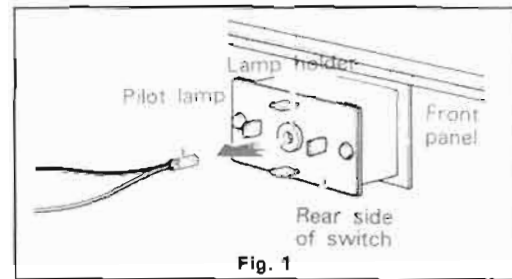

Fig. 1

4. Removal of Headphone Amplifier and Switch C. Board

- (1) Take off the top cover and front panel. (Refer to Steps 1 and 3.)
- (2) Pull out the connectors that are wired to the headphone amplifier and switch c. board.
- (3) Remove screws ① and ② and nuts ③-⑥ (Photo 3) as well as screws ① and ② shown in Photo 4.

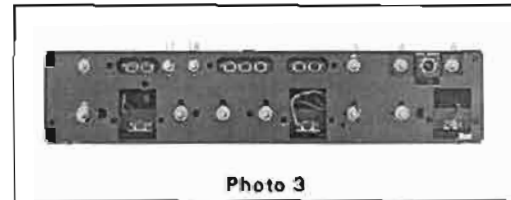

Photo 3

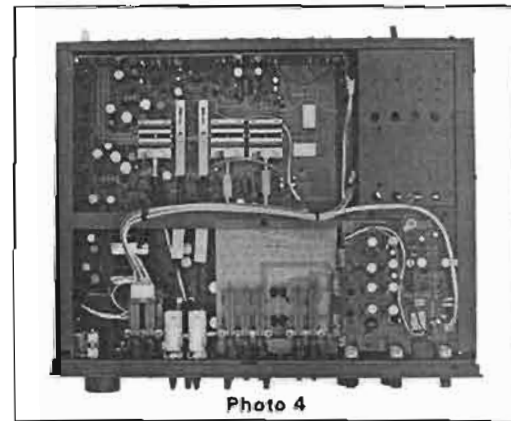

Photo 4

5. Removal of Flat Amplifier Circuit Board

- (1) Detach the top cover, bottom cover and front panel. (Refer to Steps 1, 2 and 3.)
- (2) Remove screws ⑦-⑫ and nuts ⑬ and ⑭ (Photo 3). Remove screws ① and ② (Photo 5). Now, the flat amplifier c. board can be taken off by disconnecting the lead wires.

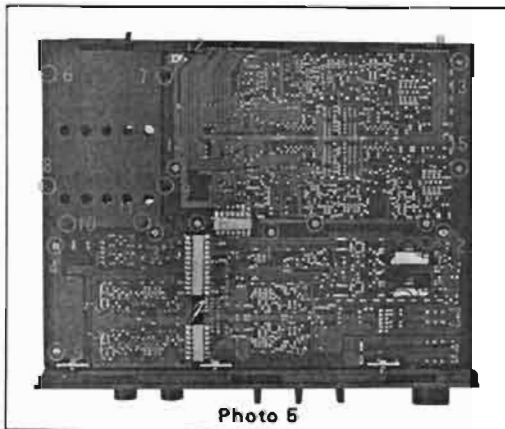

Photo 5

6. Removal of Power C. Board

- (1) Take off the top cover, bottom cover and front panel. (Refer to Steps 1, 2 and 3.)
- (2) After removing nuts (15) and (16) (Photo 3) and screws (3)~(5) (Photo 5), disconnect the lead wires. Now, the power c. board will come off.

7. Removal of Transformer Shield

- (1) Detach the top cover. (Refer to Step 1.)
- (2) Remove screws (6)~(11) shown in Photo 5.

8. Removal of Rear Panel

- (1) Take off the top cover, bottom cover and transformer shield, referring to Steps 1, 2 and 7.
 - (2) After disconnecting the internal wiring of the AC outlets, remove screws (1)~(20) and plastic rivet (A) shown in Photo 6.
- * When removing plastic rivet (A), gently hold the rivet with radio pliers and pull toward yourself.

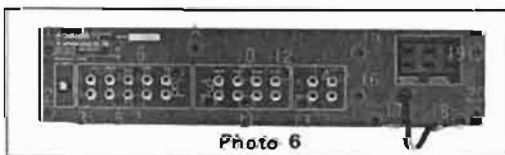

Photo 6

9. Removal of Function and Pin Jack Circuit Boards

- (1) Detach the top cover, bottom cover, front panel and rear panel. (Refer to Steps 1, 2, 3 and 8.)
- (2) Take off the two remote switches by detaching nuts (17) and (18) shown in Photo 3.

- (3) Separate the wire from the remote switch in the manner shown in Fig. 2.
- (4) Using (-) screwdriver and a pair of radio pliers, pull each switch joint in the direction of the arrow to disconnect it from the extension shaft.
- (5) After detaching screws (12)~(18) shown in Photo 5, disconnect each lead wire.

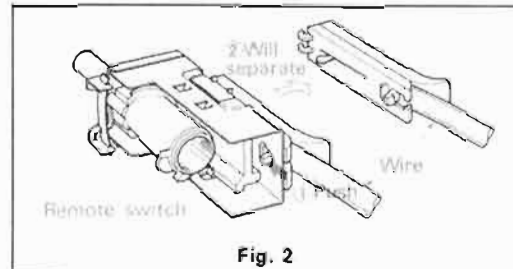

Fig. 2

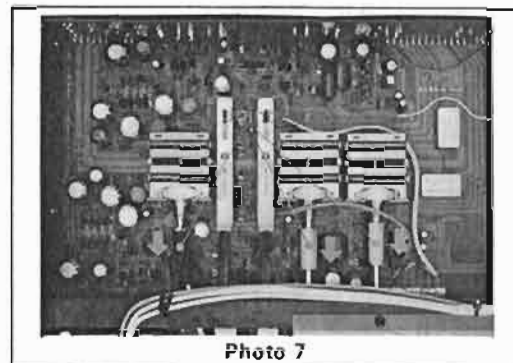

Photo 7

10. Removal of Power Transformer

- (1) Take off the top cover, bottom cover and transformer shield. (Refer to Steps 1, 2 and 7.)
- (2) After disconnecting each lead wire, take off screws (1) and (2) (Photo 8).

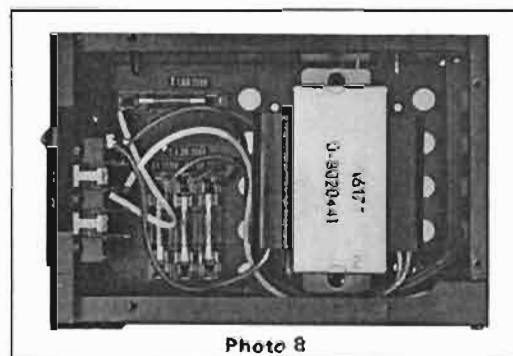

Photo 8

ADJUSTMENT

PRIOR TO ADJUSTMENT

- Adjustment is to be carried out only after 3 or 4 minutes have passed following switch-on of power, and when the amplifier's operation stabilizes.
- The volume knob should be set to minimum.

Step	Adjustment Item	Adjustment Points	Equipment	Output Terminal / Test Points	Specified Value
1	Power source voltage Adj.	Flat Amp. C. Board VR304	Electronic Voltmeter (Tester)	Flat Amp. C. Board Between TP7 (+) and TP8 (E)	30V ±0.5V
2	DC offset Adj. of equalizer section	Function C. Board VR123 (L. ch.) VR124 (R. ch.)	Electronic Voltmeter (Tester)	Function C. Board Between TP1 and TP2 Between TP3 and TP4	0V ±200mV
3	Distortion Adj. of MC Amp. section	Function C. Board VR121 (L. ch.) VR122 (R. ch.)	Oscillator (20kHz) Distortion meter	REC OUT Terminal (20kHz, 2V)	Adjust so that distortion will be minimum.

ADJUSTING POINTS

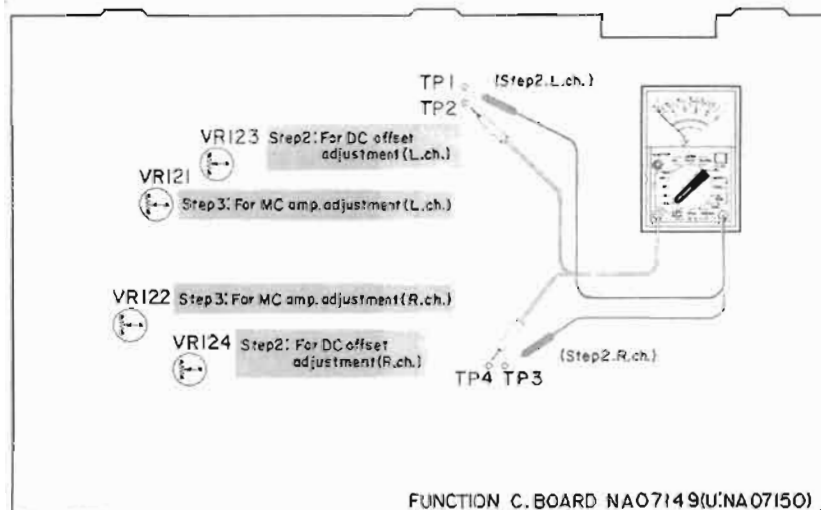
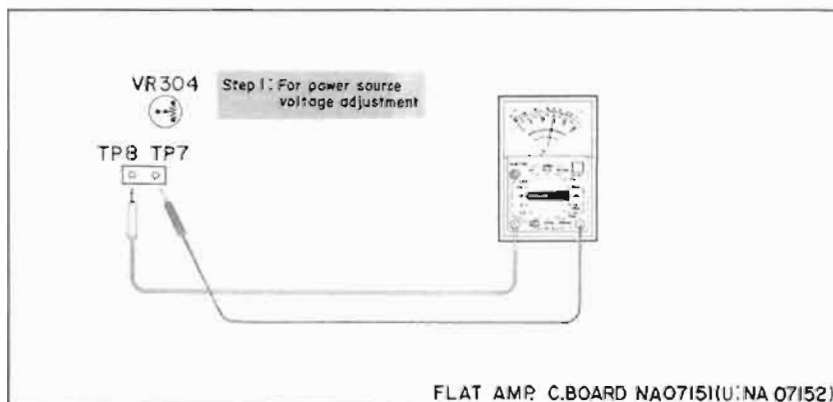

■ BLOCK DIAGRAM/LEVEL DIAGRAM

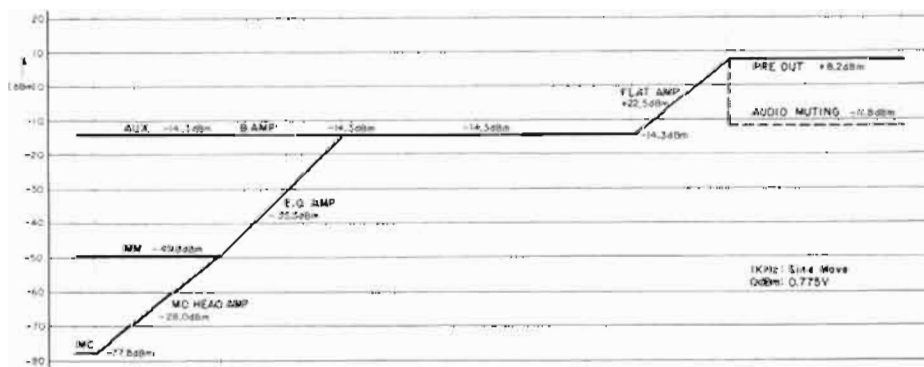
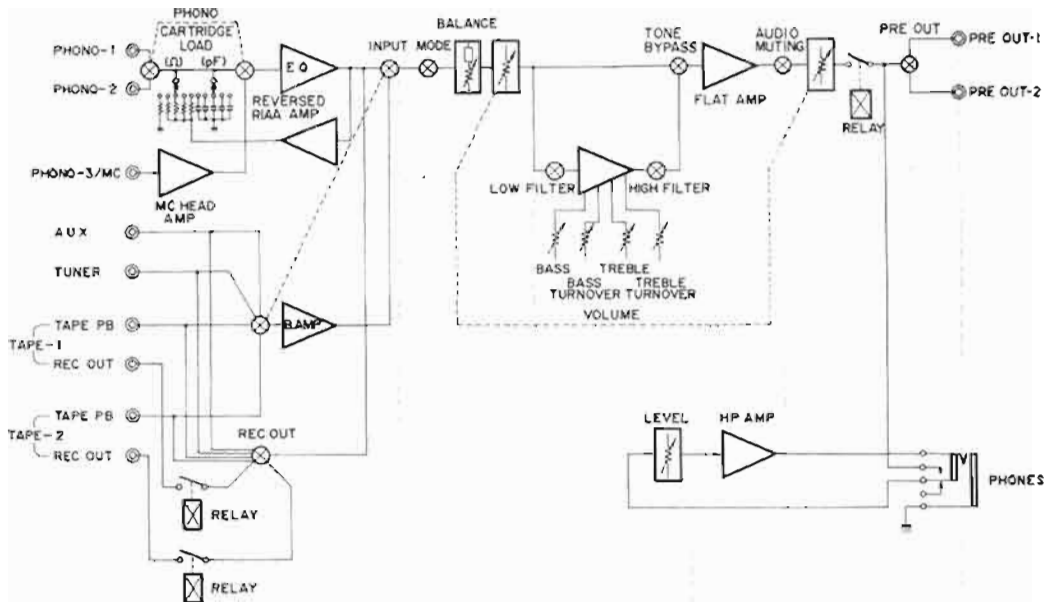

SPECIFICATIONS

Input Sensitivity/Impedance (1kHz)	
PHONO-1, 2	2.5mV/100 Ω · 33k Ω · 47k Ω · 68k Ω · 100k Ω Capacitance: 100pF · 150pF · 220pF · 330pF 470pF
PHONO-3/MC	100 μ V/50 Ω
AUX, TUNER, TAPE PB-1, 2	150mV/47k Ω
Maximum Input Levels	
PHONO-1, 2	285mV at 0.01% T-H-D
PHONO-3/MC	10mV at 0.02% T-H-D
AUX, TUNER, TAPE PB-1, 2	8.2V at 0.01% T-H-D
Output Level/Impedance	
REC OUT 1, 2	150mV/180 Ω
PRE OUT 1, 2	2.0V/600 Ω
PHONES OUT	18V (at open load, 0.05% T-H-D) /330 Ω
Maximum Output Level (20 to 20,000Hz)	
REC OUT 1, 2	15V (0.01% T-H-D)
PRE OUT 1, 2	10V (0.01% T-H-D)
PHONES OUT	18V (at open load)
Total Harmonic Distortion Ratio (20 to 20,000Hz)	
PHONO-1, 2 to PRE OUT-1, 2 (Vol. -30dB)	0.0035% (2V output)
PHONO-3/MC to PRE OUT-1, 2 (Vol. -30dB)	0.1% (2V output)
AUX, TUNER, TAPE PB-1, 2 to PRE OUT-1, 2 (Vol. max)	0.0035% (10V output)
PHONES OUT	0.02% (12mW, 8 Ω)
IM Distortion Ratio	
AUX, TUNER, TAPE PB-1, 2 to PRE OUT-1, 2	0.005% (at 10V output)
Signal-to-Noise Ratio (IHF A-Network)	
	85dB (input shorted, rated output level)
PHONO-1, 2	73dB (input open, cartridge load: 47 k Ω rated output level)
PHONO-3/MC	77dB (input shorted, rated power)
AUX, TUNER, TAPE PB-1, 2	
- TONE BYPASS: ON -	106dB
- TONE BYPASS: OFF -	100dB
Residual Noise	0.2 μ V

Frequency Response	
RIAA Deviation	20 to 20,000Hz \pm 0.2dB
AUX, TUNER, TAPE PB-1, 2	5 to 100kHz \pm 0.5dB
Tone Control Characteristics	
Bass Turnover Frequency	100Hz to 500Hz
Bass Boost/Cut	\pm 10dB at 20Hz
Treble Turnover Frequency	1kHz to 5kHz
Treble Boost/Cut	\pm 10dB at 20kHz
Filter Characteristics	
LOW FILTER	15Hz, 12dB/oct
HIGH FILTER	10kHz, 12dB/oct
Channel Separation	
PHONO-1, 2 to PRE OUT-1, 2	85dB (Vol. -30dB · 1kHz · 5.1k Ω shorted)
PHONO-3/MC to PRE OUT-1, 2	85dB (Vol. -30dB · 1kHz · 0 Ω shorted)
AUX, TUNER, TAPE PB-1, 2 to PRE OUT 1, 2	85dB (Vol. -30dB · 1kHz · 5.1k Ω shorted)
Audio Muting	-20dB

GENERAL

Power Supply	
U.S.A. and Canadian Model	120V AC, 60Hz
General Model	110/ 120/ 220/ 240V AC, 50/60Hz
North European Model	220V, 50Hz
European Model	110/ 120/ 220/ 240V AC, 50Hz
British & Australian Models	240V AC, 50Hz
Power Consumption	
	50W
AC Outlets (General Model only)	
SWITCHED	400W MAX, Total
UNSWITCHED	200W MAX, Total
Dimensions (WxHxD)	
	435x116x376mm (17-1/8")x(4-1/2")x (14-3/4")
Weight	
European & General Models	8.7kg (19 lb 3 oz)
Other Area Models	8.6kg (18 lb 15 oz)

Specifications subject to change without notice.

CIRCUIT BOARDS

(This wiring is shown in accordance with the U.S.A and CANADIAN model.)

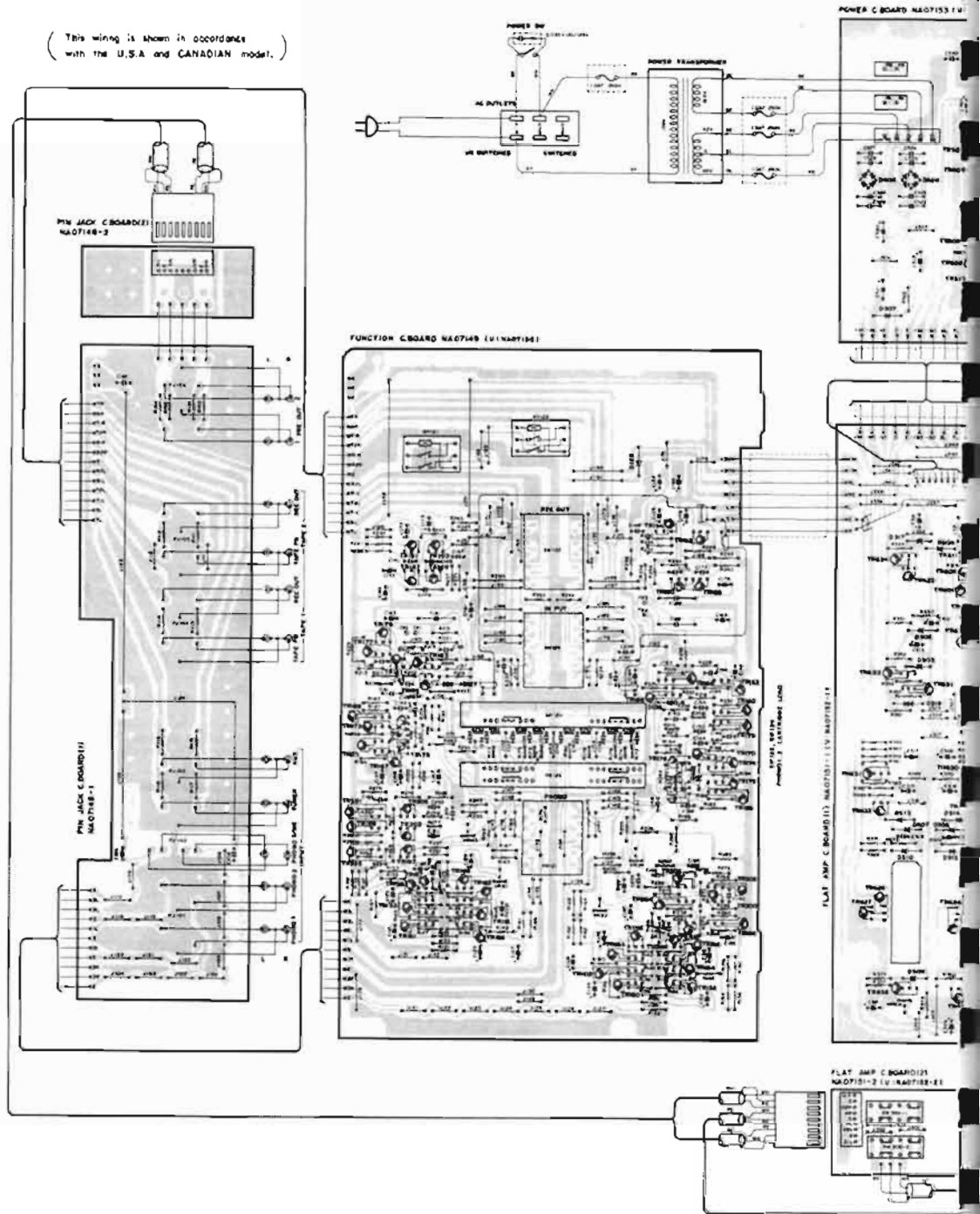

POWER C BOARD NA07153 (U: NA07154)

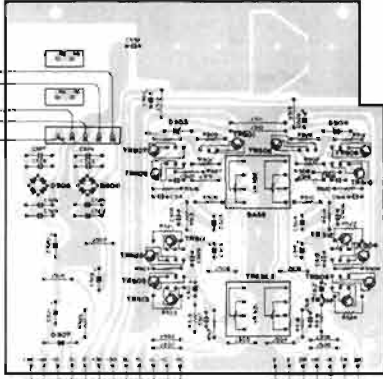

HEAD PHONE C BOARD NA07155 (U: NA07156)

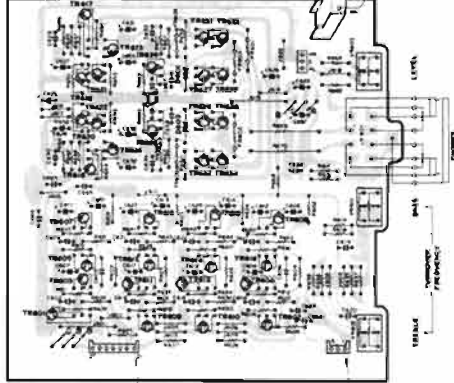

FLAT AMP C BOARD (1) NA07151 (U: NA07152)

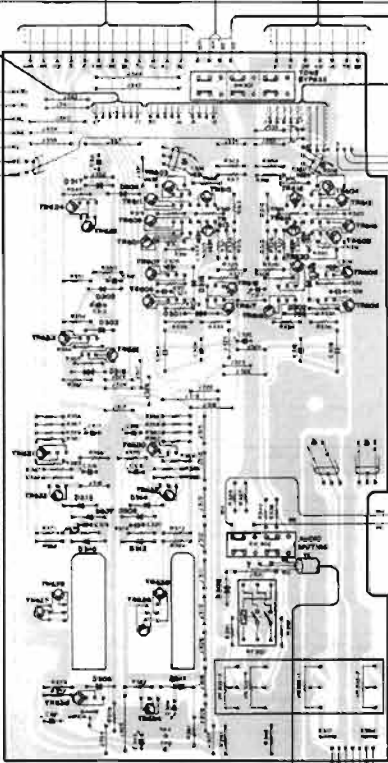

FLAT AMP C BOARD (4) NA07151-4 (U: NA07152-4)

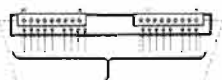

SWITCH C BOARD NA07157 (U: NA07158)

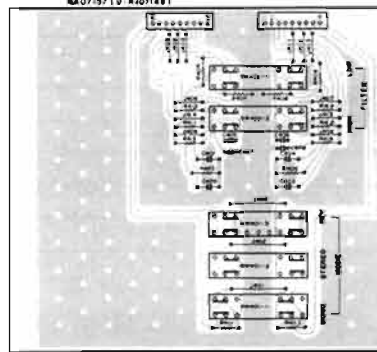

FLAT AMP C BOARD (2) NA07151-2 (U: NA07152-2)

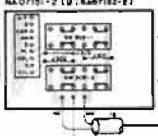

FLAT AMP C BOARD (3) NA07151-3 (U: NA07152-3)

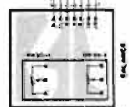

- | | |
|-------------|-------------|
| W - BLACK | 01 - BLUE |
| 02 - BROWN | 02 - GRAY |
| 03 - RED | 03 - WHITE |
| 04 - ORANGE | 04 - VIOLET |
| 05 - YELLOW | 05 - GREEN |

PARTS LIST

C-4 PRE-AMPLIFIER

SINCE 1957  **YAMAHA**
NIPPON GAKKI CO., LTD. HAMAMATSU, JAPAN

EXPLODED VIEW(1)/分解図(1)

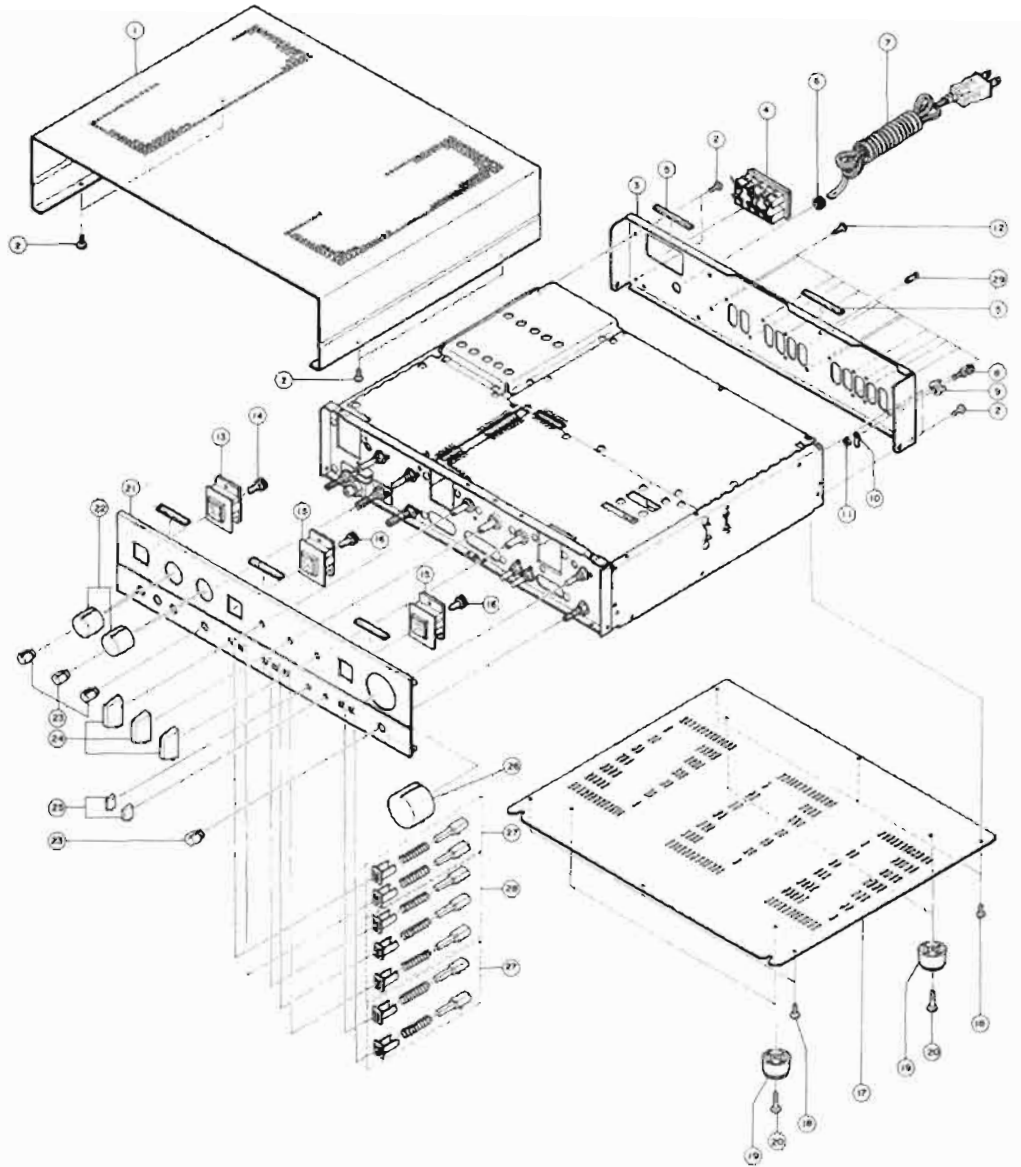

GENERAL MODEL

AUSTRALIAN MODEL

EUROPEAN MODEL

NOTH EUROPEAN AND BRITISH MODEL

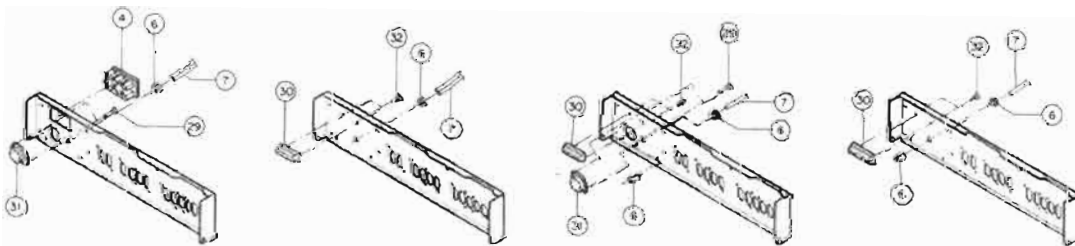

Part No.	Description	(部品名)	Remarks
1	32 00 00 NB 08 70 30 Top Cover Unit	トップカバーユニット	
2	42 00 00 E Z 00 08 00 Bonding Head Tapping Screw(3x8) FCM3-B7	ボンドヘッドタップスクリュー 2mm x 8mm	
3	32 00 00 A A 09 32 90 Rear Panel (J)	リアパネル	
4	42 00 00 L B 60 18 10 AC Outlets	AC outlets	
5	42 00 00 C B 07 61 70 Tape	防振テープ	
6	42 00 00 C B 07 27 50 Cord Stopper	コードストッパー	
7	42 00 00 MG 00 06 80 AC Cord (Black) (J)	電源コード (黒) 2.2m	
8	32 00 00 NB 08 14 80 Terminal Assy	ターミナルユニット	
9	32 00 00 C B 07 81 70 Saucer	受皿	
10	42 00 00 E V 20 03 00 Flat Washer M3 ZMC2-Y	平座金ミドリ丸	
11	42 00 00 E V 10 33 00 Hexagonal Nut M3 FCM3-B7	六角ナット	
12	42 00 00 E I 33 00 80 Bind Head Tapping Screw(3x8) FCM3-B7	ボンドヘッドタップスクリュー 2mm x 8mm	
13	32 00 00 NB 08 58 10 Push Button Assy (Orange)	プッシュボタンユニット	
14	42 00 00 C B 08 41 70 Lamp Cap of Orange Color	ランプキャップオレンジ	
15	32 00 00 NB 08 58 00 Push Button Assy (Green)	プッシュボタンユニット	
16	42 00 00 C B 08 41 80 Lamp Cap of Green Color	ランプキャップグリーン	
17	32 00 00 A A 09 32 40 Bottom Cover	ボトムカバー	
18	42 00 00 E Z 00 08 00 Bonding Head Tapping Screw(3x8) FCM3-B7	ボンドヘッドタップスクリュー 2mm x 8mm	
19	42 00 00 C B 07 94 90 Leg	脚	
20	42 00 00 E I 34 01 60 Bind Head Tapping Screw(4x16) FCM3-B7	ボンドヘッドタップスクリュー 2mm x 16mm	
21	32 00 00 NB 08 64 10 Panel Unit	パネルユニット	
22	32 00 00 B A 07 36 90 Tone Knob	トーンボタン	
23	32 00 00 B A 07 36 20 Min Knob	小ボタン	
24	32 00 00 B A 08 78 10 Switch Knob	SW ボタン	
25	32 00 00 B A 07 36 30 Min Switch Knob	SW ボタン (小)	
26	32 00 00 B A 07 36 10 Volume Knob	VOL ボタン	
27	32 00 00 NB 08 63 70 Push Button Assy	プッシュボタンユニット	
28	32 00 00 NB 08 77 10 -do-	"	
29	42 00 00 C B 08 88 80 Plastic Rivet	プラスチックリベット	
30	42 00 00 L A 00 07 60 Lug Terminal 2P CV-2 SH	ラグ端子板	
31	42 00 00 L B 29 14 80 Voltage Selector	電圧切換器	
32	42 00 00 E D 33 00 60 Bind Head Screw(3x6) FCM3-B7	ボンドヘッドタップスクリュー 2mm x 6mm	

*: New Parts

PARTS LIST/パーツリスト

EXPLODED VIEW(2)/分解図(2)

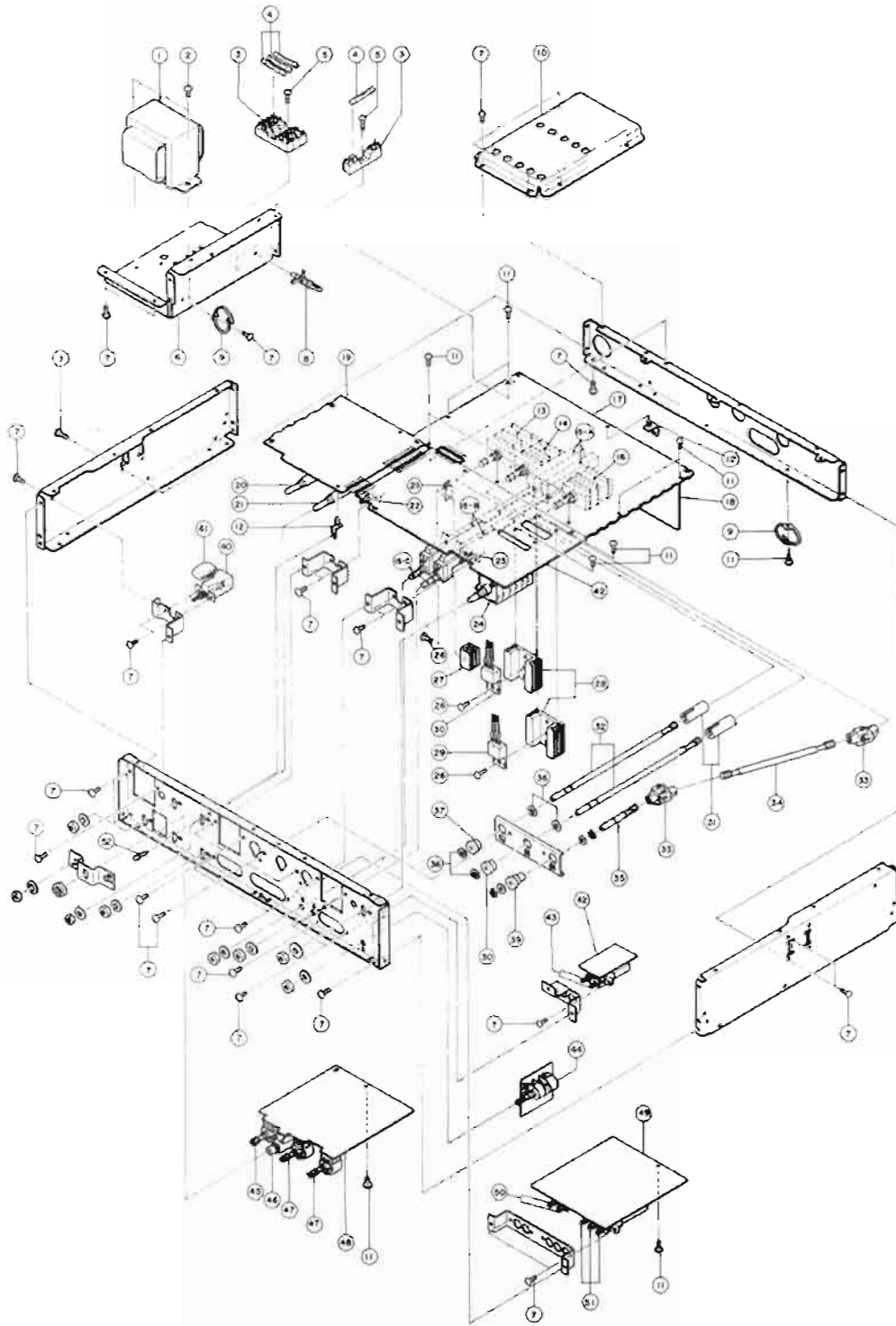

■PARTS LIST/パーツリスト

※ : New Parts

Ref. No.	Part No.	Description	(部 品 名)	Markets	Remarks
1	42 00 00 GA 61 71 00	Power Transformer (J)	電源トランス	J	
	42 00 00 GA 61 72 00	-do- (R,E)	"	R,E	
	42 00 00 GA 61 84 00	-do- (U,C)	"	U,C	
	42 00 00 GA 61 94 00	-do- (A,B)	"	A,B	
	42 00 00 GA 61 95 00	-do- (G)	"	G	
2	42 00 00 EK 31 00 30	Pan Head Sems Type(4x6) FCM3-B ϵ	鉄セムスナベ小ネジ スプリングワッシャー付		
3	42 00 00 LB 20 13 00	Fuse Holder	ヒューズホルダー	R,U,A,C	
	42 00 00 LB 20 14 70	-do- (E,G,B)	"	E,G,B	
4	42 00 00 KB 00 03 50	Fuse T 2.0A 250V	タイラッシュヒューズ	R,A	
	42 00 00 KB 00 03 30	-do- T 1.0A 250V	"	R,A	
	42 00 00 KB 00 07 10	-do- (S) T 500mA 250V	"	E,G,B	
	42 00 00 KB 00 07 30	-do- (S) T 1.0A 250V	"	E,G,B	
	42 00 00 KB 00 10 20	-do- UL SS-2 1.0A 250V	"	U,C	
5	42 00 00 EN 33 01 00	Pan Head Tapping Screw(3x10)FCM3-B ϵ	鉄アベタッピングネジ 2種 ϵ 付		
6	32 00 00 AA 09 32 80	Holder for Transformer ϵ 932B	トランスホルダー		
7	42 00 00 EZ 00 08 00	Bonding Head Tapping Screw(3x8) FCM3-B ϵ	鉄ボンディングタッピング ネジ 2種 ϵ 付		
8	32 00 00 CB 08 18 80	P.C.B Holder No.165	P.C.B ホルダー		
9	32 00 00 AA 06 57 00	Cord Stopper	束線止め		
10	32 00 00 AA 09 33 50	Transformer Shield	トランスシールド		
11	42 00 00 E i 33 00 80	Bind Head Tapping Screw(3x8)FCM3-B ϵ	鉄バインドタッピングネジ 2種 ϵ 付		
12	32 00 00 CB 08 38 40	P. C. B Holder	基板ホルダー		
13	42 00 00 KA 50 12 70	Rotary Switch S.R.A 2-2-8	ロータリー-SW		
14	42 00 00 KA 50 12 80	-do- S.R.A 2-4-5	"		
15-A	42 00 00 KA 90 08 60	Slide Switch	スライドスイッチ		
15-B	42 00 00 KA 90 08 70	Remote Switch (Wire)	リモートスイッチ(ワイヤー部)		
15-C	42 00 00 KA 90 08 80	-do- (Operate)	" (操作部)		
16	42 00 00 KA 50 12 80	Rotary Switch S.R.A 2-4-3	ロータリー-SW		
17	32 00 00 NA 07 14 90	Function C. Board	ファンクションシート	R,A,E,G,C,B	
	32 00 00 NA 07 15 00	-do- (U)	"	U	
18	32 00 00 NA 07 14 80	Pin Jack C Board	ピンジャックシート		
19	32 00 00 NA 07 15 30	Power C.Board	電源シート	R,A,E,G,C,B	
	32 00 00 NA 07 15 40	-do- (U)	"	U	
20	42 00 00 HS 31 03 30	Variable Resistor 10K Ω	ボリューム2連		
21	42 00 00 HS 31 03 30	-do- 10K Ω	"		
22	42 00 00 KA 80 04 70	Push Switch SUF1-6	プッシュスイッチ		
23	42 00 00 KA 80 08 70	-do- SUF1-4	"		
24	42 00 00 HY 00 07 10	Variable Resistor $\frac{4}{2}7K \times 2$ $\frac{2}{2}2K \times 2$	ボリューム		
25	42 00 00 i B 05 66 20	Transistor 2SB566A(S,B,C,D)	トランジスター		
26	42 00 00 ED 33 00 60	Bind Head Screw (3x6) FCM3-B ϵ	鉄バインド小ネジ		
27	42 00 00 BA 07 28 30	Heat Sink iC1625-ST	放熱器		
28	32 00 00 BA 07 36 00	-do- ϵ 7380	"		
29	42 00 00 i C 20 88 00	Transistor 2SC2088GR or 8L	トランジスター		
30	42 00 00 i A 09 41 00	-do- 2SA941GR or 8L	"		
31	32 00 00 CB 08 40 80	Joint	ジョイント		
32	32 00 00 BA 07 36 40	Extention Shaft	延長シャフト		

* : New Parts

Ref. No.	Part No.	Description	(部 品 名)	Markets	Remarks
33	32 00 00 CB 07 79 40	Joint	ジョイント		
34	32 00 00 BA 06 97 20	Extention Shaft	延長シャフト		
* 35	32 00 00 NB 08 58 80	Shaft Unit	シャフトユニット		
36	42 00 00 EV 50 15 00	E Ring	Eリング		
37	32 00 00 CB 08 40 90	Limitier for Switch	SWリミッター		
38	32 00 00 CB 07 93 90	-do.-	"		
* 39	32 00 00 CB 08 71 70	-do.-	"		
* 40	42 00 00 KA 80 08 90	Push Switch	プッシュスイッチ	J	
* 41	42 00 00 KA 80 05 00	-do.- (U,C) SDG1P	"	U,C	
	42 00 00 KA 80 05 10	-do.- (R,A,E,G,B) SDG5PE	"	R,A,E,G,B	
41	42 00 00 F Z 00 09 70	Ceramic Capacitor AC150V, 0.01	セラミックコン	J	
	42 00 00 F Z 00 01 10	Spark Suppressor Capacitor (U) AC125V, 0.033+120	スパークキラーコン	U	
	42 00 00 F Z 00 05 40	-do.- (R) DC500V AC350V, 0.033+120	"	R	
	42 00 00 F Z 00 06 90	-do.- (E,G,B) AC250V, 0.022	"	E,G,B	
	42 00 00 F Z 00 11 20	-do.- (C) AC125V, 0.033+120	"	C	
* 42	32 00 00 NA 07 15 10	Flat Amp. C Board	フラットアンプシート	R,A,E,G,C,B	
	32 00 00 NA 07 15 20	-do.- (U)	"	U	
43	42 00 00 KA 80 08 30	Push Switch	プッシュスイッチ		
* 44	42 00 00 HS 31 03 10	Variable Resistor 10K Ω x 2	ボリューム		
* 45	42 00 00 HS 31 03 20	-do.- 10K Ω x 2	"		
* 46	42 00 00 L B 30 08 30	Phone Jack	ホーンジャック		
* 47	42 00 00 HS 31 03 40	Variable Resistor 20K Ω x 2	ボリューム		
* 48	32 00 00 NA 07 15 50	Headphone Amp. C Board	ヘッドホンアンプシート	R,A,E,G,C,B	
	32 00 00 NA 07 15 60	-do.- (U)	"	U	
* 49	32 00 00 NA 07 15 70	Switch C Board	スイッチシート	R,A,E,G,C,B	
	32 00 00 NA 07 16 90	-do.- (U)	"	U	
* 50	42 00 00 KA 80 08 10	Push Switch SUF2-B	プッシュスイッチ		
* 51	42 00 00 KA 80 08 20	-do.- SUF3-B	"		
52	32 00 00 CB 06 88 80	Plastic Rivet	プラスチックリベット		

New Parts

Ref. No.	Part No.	Description	(部 品 名)	Markets	Remarks
	32 00 00 NA 07 14 80	Pin Jack C.Board	ピンジャックシート		
C101	42 00 00 FG 24 42 20	Ceramic Capacitor 0.022 μ F/50V	セラコン		
PJ102	42 00 00 LB 20 14 60	Pin Jack 2P	ピンジャック基板型		
PJ103	42 00 00 LB 40 04 00	-do.- T-5593 4P	"		
PJ104	42 00 00 LB 40 04 90	-do.- 4P	"		
R101	42 00 00 HK 15 74 70	Carbon Resistor FCR25 47K Ω	カーボン抵抗		
R104	42 00 00 HK 15 92 20	-do.- 2.2M Ω	"		
R111	42 00 00 LB 30 04 70	Connect Pin L Type 3P 2373-03A	L型コネクトピン		
R118	42 00 00 LB 50 03 00	-do.- 5P 2373-05A	"		
	42 00 00 LB 60 25 30	Miniature Connect Pin 9P 5046-09A	L型ミニチュアコネクトピン		
	32 00 00 NA 07 14 90	Function C.Board	ファンクションシート	RA.E.G.C.B	
	32 00 00 NA 07 15 00	-do.- (U)	"	U	
C189	42 00 00 FA 11 32 20	Mylar Capacitor 0.0022 μ F/50V	マイラーコン		
C190	42 00 00 FA 11 32 20	-do.- 0.0022 μ F/50V	"		
C143	42 00 00 FA 11 32 20	-do.- 0.0022 μ F/50V	"		
C155	42 00 00 FA 11 41 00	-do.- 0.01 μ F/50V	"		
C156	42 00 00 FA 11 41 00	-do.- 0.01 μ F/50V	"		
C153	42 00 00 FA 15 31 00	-do.- 0.001 μ F/50V	"		
C154	42 00 00 FA 15 31 00	-do.- 0.001 μ F/50V	"		
C165	42 00 00 FA 15 38 20	-do.- 0.0082 μ F/50V	"		
C166	42 00 00 FA 15 38 20	-do.- 0.0082 μ F/50V	"		
C119	42 00 00 FA 11 31 00	-do.- 0.001 μ F/50V	"		
C200	42 00 00 FA 11 31 00	-do.- 0.001 μ F/50V	"		
C203	42 00 00 FA 11 31 00	-do.- 0.001 μ F/50V	"		
C204	42 00 00 FA 11 31 00	-do.- 0.001 μ F/50V	"		
C179	42 00 00 FC 12 81 00	MM Capacitor 1 μ F/100V	メタライズドポリエスタルフィルムコン		
C180	42 00 00 FC 12 81 00	MM Capacitor 1 μ F/100V	MMコン		
C161	42 00 00 FC 10 61 00	MM Capacitor 1 μ F/100V	MMコン		
C162	42 00 00 FC 10 61 00	MM Capacitor 1 μ F/100V	MMコン		
C157	42 00 00 FD 15 22 20	Polystyrene Capacitor 220 μ F/50V	スチコンタテ型		
C158	42 00 00 FD 15 22 20	-do.- 220 μ F/50V	"		
C133	42 00 00 FD 15 14 70	-do.- 47pF/50V	"		
C134	42 00 00 FD 15 14 70	-do.- 47pF/50V	"		
C137	42 00 00 FD 15 21 50	-do.- 150pF/50V	"		
C138	42 00 00 FD 15 21 50	-do.- 150pF/50V	"		
C139	42 00 00 FD 15 22 70	-do.- 270pF/50V	"		
C140	42 00 00 FD 15 22 70	-do.- 270pF/50V	"		
C141	42 00 00 FD 15 23 90	-do.- 390pF/50V	"		
C142	42 00 00 FD 15 23 90	-do.- 390pF/50V	"		
C145	42 00 00 FF 06 11 00	-do.- 10pF/125V	"		
C146	42 00 00 FF 06 11 00	-do.- 10pF/125V	"		
C171	42 00 00 FF 06 11 00	-do.- 10pF/125V	"		
C172	42 00 00 FF 06 11 00	-do.- 10pF/125V	"		
C187	42 00 00 FF 06 21 00	-do.- 100pF/125V	"		
C188	42 00 00 FF 06 21 00	-do.- 100pF/125V	"		
C135	42 00 00 FD 15 18 20	-do.- 82pF/50V	"		
C136	42 00 00 FD 15 18 20	-do.- 82pF/50V	"		
C169	42 00 00 FD 15 21 00	-do.- 100pF/50V	"		
C170	42 00 00 FD 15 21 00	-do.- 100pF/50V	"		
C197	42 00 00 FD 15 21 00	-do.- 100pF/50V	"		
C198	42 00 00 FD 15 21 00	-do.- 100pF/50V	"		
C201	42 00 00 FD 15 21 00	-do.- 100pF/50V	"		
C202	42 00 00 FD 15 21 00	-do.- 100pF/50V	"		
C173	42 00 00 FJ 11 73 30	Electrolytic Capacitor 33 μ F/6.3V	ケミコンタテ型		
C174	42 00 00 FJ 11 73 30	Electrolytic Capacitor 33 μ F/6.3V	ケミコンタテ型		
C175	42 00 00 FJ 21 81 00	-do.- 100 μ F/6.3V	"		
C176	42 00 00 FJ 21 81 00	-do.- 100 μ F/6.3V	"		
C129	42 00 00 FJ 12 91 00	-do.- 1000 μ F/10V	"		
C132	42 00 00 FJ 12 91 00	-do.- 1000 μ F/10V	"		
C181	42 00 00 FJ 26 61 00	-do.- 1 μ F/50V	"		
C184	42 00 00 FZ 00 14 50	-do.- 1 μ F/80V	"		
C157	42 00 00 FZ 00 14 50	-do.- 1 μ F/80V	"		
C160	42 00 00 FZ 00 12 50	-do.- 47 μ F/6.3V	"		
C125	42 00 00 FZ 00 12 50	-do.- 47 μ F/6.3V	"		
C128	42 00 00 FZ 00 12 50	-do.- 47 μ F/6.3V	"		
C121	42 00 00 FZ 00 12 60	-do.- 220 μ F/6.3V	"		
C124	42 00 00 FZ 00 12 60	-do.- 220 μ F/6.3V	"		
C147	42 00 00 FM 10 81 00	By-Polar Capacitor 100 μ F/6.3V	B.Pコン		
C148	42 00 00 FM 10 81 00	By-Polar Capacitor 100 μ F/6.3V	B.Pコン		
C185	42 00 00 FM 11 61 00	-do.- 1 μ F/50V	"		
C186	42 00 00 FM 11 61 00	-do.- 1 μ F/50V	"		
C177	42 00 00 FM 59 74 70	-do.- 47 μ F/25V	"		
C178	42 00 00 FM 59 74 70	-do.- 47 μ F/25V	"		
C163	42 00 00 FM 11 74 70	By-Polar Electrolytic Cap. 47 μ F/50V	B.Pケミコン		
C164	42 00 00 FM 11 74 70	By-Polar Electrolytic Cap. 47 μ F/50V	B.Pケミコン		

※ : New Parts

Ref. No.	Part No.	Description	(部 品 名)	Markets	Remarks
C149 C150	42 00 00 F T 17 41 50	Electrolytic Capacitor 0.015 μ F/100V	ポリプロピレンフィルムコン		
C151 C152	42 00 00 F T 17 45 60	-do- 0.056 μ F/100V	"		
C191 C192	42 00 00 F T 17 31 50	-do- 0.0015 μ F/100V	"		
C193 C194	42 00 00 F T 17 35 60	-do- 0.0056 μ F/100V	"		
R127 R142	42 00 00 HK 15 41 00	Carbon Resistor FCR25 10 Ω	カーボン抵抗		
R226 R228	42 00 00 HK 15 44 70	-do- 47 Ω	"		
R229 R230	42 00 00 HK 15 45 60	Carbon Resistor 56 Ω	"		
R183 R184	42 00 00 HK 15 46 80	-do- 68 Ω	"		
R275 R278	42 00 00 HK 15 46 80	-do- 68 Ω	"		
R223 R224	42 00 00 HK 15 48 20	-do- 82 Ω	"		
R169 R170	42 00 00 HK 15 51 50	-do- 150 Ω	"		
R185 R188	42 00 00 HK 15 51 50	-do- 150 Ω	"		
R219 R220	42 00 00 HK 15 51 50	-do- 150 Ω	"		
R247 R248	42 00 00 HK 15 51 50	-do- 150 Ω	"		
R251 R252	42 00 00 HK 15 51 50	-do- 150 Ω	"		
R261 R264	42 00 00 HK 15 51 50	-do- 150 Ω	"		
R296	42 00 00 HK 15 52 20	-do- 270 Ω	"		
R237 R238	42 00 00 HK 15 52 20	-do- 220 Ω	"		
R265 R268	42 00 00 HK 15 52 20	-do- 220 Ω	"		
R295	42 00 00 HJ 15 52 20	-do- R25 220 Ω	"		
R221 R222	42 00 00 HK 15 54 70	-do- FCR25 470 Ω	"		
R153 R168	42 00 00 HK 15 58 20	-do- 820 Ω	"		
R181 R182	42 00 00 HK 15 51 00	-do- 100 Ω	"		
R151 R152	42 00 00 HK 15 61 00	-do- 1K Ω	"		
R121 R122	42 00 00 HK 15 61 00	-do- 1K Ω	"		
R280 R284	42 00 00 HK 15 61 00	-do- 1K Ω	"		
R257 R258	42 00 00 HK 15 61 20	-do- 1.2K Ω	"		
R203 R206	42 00 00 HK 15 61 50	-do- 1.5K Ω	"		
R239 R240	42 00 00 HK 15 61 50	-do- 1.5K Ω	"		
R249 R250	42 00 00 HK 15 61 50	-do- 1.5K Ω	"		
R125 R126	42 00 00 HK 15 61 80	-do- 1.8K Ω	"		
R211 R212	42 00 00 HK 15 62 70	-do- FCR25 2.7K Ω	"		
R269 R270	42 00 00 HK 15 63 30	-do- 3.3K Ω	"		
R197 R200	42 00 00 HK 15 63 90	-do- 3.9K Ω	"		
R123 R124	42 00 00 HK 15 64 70	-do- 4.7K Ω	"		
R143 R146	42 00 00 HK 15 64 70	-do- 4.7K Ω	"		
R213 R214	42 00 00 HK 15 64 70	-do- 4.7K Ω	"		
R243 R244	42 00 00 HK 15 65 60	-do- 5.6K Ω	"		
R271 R272	42 00 00 HK 15 65 60	-do- 5.6K Ω	"		
R191 R194	42 00 00 HK 15 66 80	-do- 6.8K Ω	"		
R195 R196	42 00 00 HK 15 68 20	-do- 8.2K Ω	"		
R233 R234	42 00 00 HK 15 71 00	-do- 10K Ω	"		
R273 R274	42 00 00 HK 15 71 00	-do- 10K Ω	"		
R285 R286	42 00 00 HK 15 71 00	-do- 10K Ω	"		
R189 R190	42 00 00 HK 15 73 30	-do- FCR25 33K Ω	"		

* : New Parts

Ref. No.	Part No.	Description	(部 品 名)	Markets	Remarks
R253 R254	42 00 00 HK 15 73 30	Carbon Resistor FCR25 33K Ω	カーボン抵抗		
R235 R236	42 00 00 HK 15 74 70	-do- 47K Ω	"		
R215 R216	42 00 00 HK 15 75 60	-do- 56K Ω	"		
R241 R242	42 00 00 HK 15 75 60	-do- 58K Ω	"		
R245 R246	42 00 00 HK 15 75 60	-do- 56K Ω	"		
R259 R260	42 00 00 HK 15 75 60	-do- 58K Ω	"		
R179	42 00 00 HK 15 91 00	-do- 1M Ω	"		
R255 R256	42 00 00 HK 15 81 00	-do- 100K Ω	"		
R231 R232	42 00 00 HK 15 51 80	-do- 180 Ω	"		
R171 R172	42 00 00 HK 55 51 00	-do- ELS25 100 Ω	"		
R173 R174	42 00 00 HK 55 84 70	-do- 470K Ω	"		
R175 R176	42 00 00 HK 55 91 00	-do- ELS25 1M Ω	"		
R180	42 00 00 HK 55 91 00	-do- 1M Ω	"		
R177 R178	42 00 00 HK 55 92 20	-do- 2.2M Ω	"		
R287 R294	42 00 00 HK 55 92 20	-do- 2.2M Ω	"		
R201 R202	42 00 00 HU 07 51 00	Metal Film Resistor RE35 100 Ω	金属膜抵抗		
R207 R208	42 00 00 HU 07 64 70	-do- 4.7K Ω	"		
R209 R210	42 00 00 HU 07 75 60	-do- 56K Ω	"		
R277 R278	42 00 00 HU 07 74 70	-do- 47K Ω	"		
R279 R280	42 00 00 HU 87 85 60	-do- RP42A 560K Ω	"		
R147 R150	42 00 00 HU 87 51 10	-do- 110 ρ	"		
VR121 VR122	42 00 00 HT 41 00 10	Variable Resistor 10KR B220 Ω	ソリッド VR		
VR123 VR124	42 00 00 HT 41 00 40	-do- B4.7K Ω	"		
T-167 T-170	42 00 00 I A 06 73 10	Transistor 2SA673A	トランジスター		
T-155 T-156	42 00 00 I A 06 73 10	-do- 2SA673A	"		
T-199 T-202	42 00 00 I A 06 73 10	-do- 2SA673A	"		
T-177 T-180	42 00 00 I A 09 41 00	-do- 2SA941	"		
T-159 T-166	42 00 00 I B 07 37 00	-do- 2SB737	"		
T-197 T-198	42 00 00 I C 12 13 10	-do- 2SC1213A	"		
T-171 T-174	42 00 00 I C 20 88 00	-do- 2SC2088	"		
T-185 T-188	42 00 00 I C 20 88 00	-do- 2SC2088	"		
T-203 T-206	42 00 00 I C 20 88 00	-do- 2SC2088	"		
T-151 T-158	42 00 00 I C 23 00 00	-do- 2SC2300	"		
T-189 T-190	42 00 00 I E 10 05 50	FET 2SK68A	FET		
T-175 T-176	32 00 00 I E 10 11 40	-do- 2SK100	"		
T-191 T-192	42 00 00 I B 06 49 00	Transistor 2SB649	トランジスター		
T-193 T-194	42 00 00 I D 06 69 00	-do- 2SD669	"		
T-183 T-184	42 00 00 I A 09 14 50	Pair Transistor 2SA914 O.R.S.T	ペアトランジスター		
T-181 TR182	42 00 00 I C 19 53 50	-do- 2SC1953 O.R.S.T	"		
D125	42 00 00 I F 00 00 40	Diode 1S1555	ダイオード		
D121 D122	42 00 00 I F 00 05 70	Zener Diode HZ6C	ツェナーダイオード		
D127 D128	42 00 00 I F 00 07 70	Varistor VD1212	バリスター		
SW123	42 00 00 KA 50 12 60	Rotary Switch SRA 2-4-5	ロータリーSW		
SW122	42 00 00 KA 50 12 70	-do- 2-2-6	"		
SW121	42 00 00 KA 50 12 80	-do- 2-4-3	"		

* New Parts

Ref. No.	Part No.	Description	(部 品 名)	Markets	Remarks
* SW124 SW125	42 00 00 KA 90 08 60	Slide Switch	6-5	スライド SW	
* RY121 RY122	42 00 00 KC 00 03 00	Reed Relay	RL6442-H132	リードリレー	
	42 00 00 LB 10 01 10	Connect Pin		ダイヤモンドコネクタピン	
	42 00 00 CB 08 38 40	Holder for C.Board	≒8384	基板ホルダー	
* 32 00 00 CB 08 17 00	Clip	≒8170	クリップ		
	32 00 00 NA 07 15 10	Flat Amp. C.Board		フラットアンプシート	R.A.E.G.C.B
	32 00 00 NA 07 15 20	-do- (U)		"	U
C307 C308	42 00 00 FC 10 61 00	Capacitor	1 μ F/100V	MMコン	
* C303 C306	42 00 00 FF 06 11 50	Polystyrene Capacitor	15pF/125V	スチコンタテ型	
C329 C330	42 00 00 FD 15 14 70	-do-	47pF/50V	"	
C333 C334	42 00 00 FD 15 22 20	-do-	220pF/50V	"	
C319 C320	42 00 00 FG 14 31 00	Ceramic Capacitor	0.001 μ F/50V	セラコン	
C312	42 00 00 FZ 00 09 00	Electrolytic Capacitor	2.2 μ F/50V	ケミコンMS	
* C331	42 00 00 FJ 24 64 70	-do-	4.7 μ F/25V	ケミコンタテ型	
* C315 C316	42 00 00 FJ 24 62 20	-do-	2.2 μ F/25V	"	
C323 C324	42 00 00 FZ 00 13 70	-do-	47 μ F/35V	"	
* C311	42 00 00 FZ 00 14 50	-do-	1 μ F/80V	"	
* C315	42 00 00 FZ 00 14 50	-do-	1 μ F/80V	"	
* C317 C318	42 00 00 FJ 26 81 00	-do-	100 μ F/50V	"	
* C321	42 00 00 FJ 25 74 70	-do-	47 μ F/35V	"	
C327 C328	42 00 00 FA 11 41 00	Mylar Capacitor	0.01 μ F	マイラーコン	
* C309 C310	42 00 00 FM 59 82 20	By-Polar Capacitor	220 μ F/25V	B Pコン	
* C313	42 00 00 FM 63 73 30	Z Capacitor \pm 10%	33 μ F/16V	Z コン	
R391 R392	42 00 00 HK 15 54 70	Carbon Resistor	F-CR25 470 Ω	カーボン抵抗	
R356 R362	42 00 00 HK 15 35 60	-do-	5.6 Ω	"	
R333 R336	42 00 00 HK 15 44 70	-do-	47 Ω	"	
R341 R342	42 00 00 HK 15 44 70	-do-	47 Ω	"	
R383 R384	42 00 00 HK 15 51 00	-do-	100 Ω	"	
R307 R308	42 00 00 HK 15 51 50	-do-	150 Ω	"	
R311 R312	42 00 00 HK 15 51 50	-do-	150 Ω	"	
R327 R328	42 00 00 HK 15 51 50	-do-	150 Ω	"	
R331 R332	42 00 00 HK 15 51 50	-do-	150 Ω	"	
R305 R306	42 00 00 HK 15 52 20	-do-	220 Ω	"	
R317 R318	42 00 00 HK 15 52 20	-do-	220 Ω	"	
R329 R330	42 00 00 HK 15 52 20	-do-	220 Ω	"	
R363 R364	42 00 00 HK 15 52 20	-do-	220 Ω	"	
R369 R370	42 00 00 HK 15 52 20	-do-	220 Ω	"	
R339 R340	42 00 00 HK 15 52 70	-do-	270 Ω	"	
R323 R324	42 00 00 HK 15 53 90	-do-	390 Ω	"	
R379	42 00 00 HK 15 61 20	-do-	1.2K Ω	"	
R315 R316	42 00 00 HK 15 61 80	-do-	1.8K Ω	"	
R313 R314	42 00 00 HK 15 62 20	-do-	2.2K Ω	"	
R337 R338	42 00 00 HK 15 62 20	-do-	2.2K Ω	"	
R350	42 00 00 HK 15 62 20	-do-	2.2K Ω	"	

* : New Parts

Ref. No.	Part No.	Description	(部 品 名)	Markets	Remarks
R353 R354	42 00 00 HK 15 62 20	Carbon Resistor 2.2K Ω	カーボン抵抗		
R321 R322	42 00 00 HK 15 62 70	-do- 2.7K Ω	"		
R371 R372	42 00 00 HK 15 63 90	-do- 3.9K Ω	"		
R373 R374	42 00 00 HK 15 64 70	-do- 4.7K Ω	"		
R385 R386	42 00 00 HK 15 64 70	-do- 4.7K Ω	"		
R377	42 00 00 HK 15 64 70	-do- 4.7K Ω	"		
R347	42 00 00 HK 15 65 60	-do- 5.6K Ω	"		
R381 R382	42 00 00 HK 15 68 20	-do- 8.2K Ω	"		
R325 R326	42 00 00 HK 15 71 00	-do- 10K Ω	"		
R365 R368	42 00 00 HK 15 71 00	-do- 10K Ω	"		
R375	42 00 00 HK 15 71 00	-do- 10K Ω	"		
R319 R320	42 00 00 HK 15 73 30	-do- 33K Ω	"		
R352	42 00 00 HK 15 81 00	-do- 100K Ω	"		
R303 R304	42 00 00 HK 15 82 20	-do- 220K Ω	"		
R301 R302	42 00 00 HU 07 53 90	Metal Film Resistor RE35 390 Ω	金属被膜抵抗		
R387	42 00 00 HK 15 36 80	Carbon Resistor FCR25 6.8 Ω	カーボン抵抗		
R389 R390	42 00 00 HK 15 71 20	-do- 12K Ω	"		
R351	42 00 00 HK 15 81 80	-do- 180K Ω	"		
VR301	42 00 00 HS 31 03 10	Variable Resistor 10K Ω \times 2	ボリューム		
VR304	42 00 00 HT 41 00 10	-do- 10KR B220 Ω	ソリッドVR		
VR302	42 00 00 HY 00 07 10	-do- 4.7K Ω \times 2 2.2K Ω \times 2	ボリューム		
	42 00 00 LA 00 21 10	Wire Lapping Terminal P=5 2P	I型ラッピング端子板		
	42 00 00 JB 00 06 10	Pilot Lamp 14.5V80mA	パイロットランプリード式		
	42 00 00 LB 30 08 10	Miniature Connect Pin 3P	ミニチュアコネクタコンピン		
	42 00 00 LB 60 10 00	-do- 7P	"		
	42 00 00 LB 60 25 70	-do- 9P	"		
	42 00 00 LB 60 25 30	-do- (L Type) 9P	" L型		
	42 00 00 BA 07 28 30	Heat Sink IC1625-ST	放熱器		
	32 00 00 BA 07 36 00	-do- \pm 7360	"		
	42 00 00 Mi 06 66 90	Flat Wire 3-120-2.5	フラット線		
	42 00 00 Mi 06 67 70	-do- 4-100-2.5	"		
	42 00 00 Mi 06 68 60	-do- 5-100-2.5	"		
	42 00 00 Mi 06 69 50	-do- 7-100-2.5	"		
	42 00 00 Mi 06 69 30	-do- 7-60-2.5	"		
	32 00 00 NA 07 15 30	Power C Board	電源シート	R.A.E.G.C.B	
	32 00 00 NA 07 15 40	-do- (U)	"	U	
C515 C516	42 00 00 FA 11 31 00	Mylar Capacitor 0.001 μ F/50V	マイラーコン		
C507 C508	42 00 00 FH 61 06 00	Ceramic Capacitor 8pF/500V	セラコン		
C505 C506	42 00 00 FG 21 11 00	-do- 10pF/50V	"		
C517 C518	42 00 00 FG 21 14 70	-do- 47pF/50V	"		
C509 C510	42 00 00 FG 21 21 00	-do- 100pF/50V	"		
C523 C524	42 00 00 FH 23 41 00	-do- 0.01 μ F/500V	"		
C530	42 00 00 FG 24 42 20	-do- 0.022 μ F/50V	"		
C511 C512	42 00 00 FJ 24 64 70	Electrolytic Capacitor 4.7 μ F/25V	ケミコンタテ型		

* : New Parts

Ref. No.	Part No.	Description	(部 品 名)	Marking	Remarks
C519	42 00 00 F J 14 91 00	Electrolytic Capacitor 1000 μ F/25V	ケミコンタテ型		
C501 C502	42 00 00 F J 26 61 00	-do- 1 μ F/50V	"		
C520 C521	42 00 00 F J 26 84 70	-do- 470 μ F/50V	"		
C513 C514	42 00 00 F J 21 82 20	-do- 220 μ F/6.3V	"		
C503 C504	42 00 00 F M 09 71 00	By-Polar Capacitor 10 μ F/16V	B.P.コン		
R505 R506	42 00 00 H K 15 51 50	Carbon Resistor FCR25 150 Ω	カーボン抵抗		
R511 R512	42 00 00 H K 15 51 50	-do- 150 Ω	"		
R519 R520	42 00 00 H K 15 53 30	-do- 330 Ω	"		
R521 R524	42 00 00 H K 15 54 70	-do- 470 Ω	"		
R507 R508	42 00 00 H K 15 61 00	-do- 1K Ω	"		
R515 R516	42 00 00 H K 15 61 00	-do- 1K Ω	"		
R525	42 00 00 H K 15 61 00	-do- 1K Ω	"		
R509 R510	42 00 00 H K 15 71 20	-do- 12K Ω	"		
R513 R514	42 00 00 H K 15 71 20	-do- 12K Ω	"		
R501 R502	42 00 00 H K 15 71 50	-do- 15K Ω	"		
R503 R504	42 00 00 H K 15 73 30	-do- 33K Ω	"		
R517 R518	42 00 00 H K 15 81 80	-do- 180K Ω	"		
T-503	42 00 00 I A 09 41 00	Transistor 2SA941	トランジスター		
T-508 T-511	42 00 00 I C 04 58 80	-do- 2SC458	"		
T-514	42 00 00 I C 20 88 00	-do- 2SC2088	"		
T-501 T-502	42 00 00 I C 20 88 00	-do- 2SC2088	"		
T-509 T-510	42 00 00 I C 20 88 00	-do- 2SC2088	"		
D507	42 00 00 I H 00 02 40	Diode 1S1885	ダイオード		
D508 D509	42 00 00 I H 00 04 70	-do- 1D4B-1	"		
D503 D504	42 00 00 I F 00 03 50	Zener Diode WZ130	ツェナーダイオード		
VR501 VR502	42 00 00 H S 31 03 30	Variable Resistor 10K Ω x 2	ボリューム2連		
	42 00 00 L A 00 21 10	Lapping Pin 1 Type P=5 2P	1巻ラッピング電子線		
	42 00 00 L A 00 20 40	-do- P=5 5P	"		
	32 00 00 B B 06 64 30	Shield Plate \pm 6643	シールド板		
	42 00 00 C B 08 38 40	P.C.B Holder \pm 8384	基板ホルダー		
	32 00 00 N A 07 15 50	Head Phone Amp. C.Board	ヘッドホンアンプシート	R,A,E,G,C,B	
	32 00 00 N A 07 15 60	-do- (U)	"	U	
C659 C660	42 00 00 F A 11 31 00	Mylar Capacitor 0.001 μ F/50V	マイラーコン		
C619 C620	42 00 00 F A 15 31 80	-do- 0.0018 μ F/50V	"		
C605 C606	42 00 00 F A 15 52 20	-do- 0.22 μ F/50V	"		
C666 C668	42 00 00 F G 24 42 20	Ceramic Capacitor 0.022 μ F/50V	セラコン		
C663 C665	42 00 00 F G 24 42 20	-do- 0.022 μ F/50V	"		
C603 C604	42 00 00 F G 21 21 00	-do- 100pF/50V	"		
C609 C610	42 00 00 F G 21 21 00	-do- 100pF/50V	"		
C615 C616	42 00 00 F G 21 21 00	-do- 100pF/50V	"		
C621 C622	42 00 00 F G 21 21 00	-do- 100pF/50V	"		
C429 C430	42 00 00 F A 11 31 00	Mylar Capacitor 0.001 μ F/50V	マイラーコン		
C633 C634	42 00 00 F G 21 06 00	Ceramic Capacitor 6pF/50V	セラコン		
C657 C658	42 00 00 F H 01 11 00	-do- 10pF/50V	"		
C601 C602	42 00 00 F J 21 74 70	Electrolytic Capacitor 47 μ F/6.3V	ケミコンタテ型		

* New Parts

Ref. No.	Part No.	Description	(部 品 名)	Markets	Remarks
C613 C614	42 00 00 FJ 21 74 70	Electrolytic Capacitor	47 μ F/6.3V	ケミコンタテ型	
C631 C632	42 00 00 FJ 21 82 20	-do-	220 μ F/6.3V	"	
C607 C608	42 00 00 FJ 23 81 00	-do-	100 μ F/16V	"	
C611 C612	42 00 00 FJ 23 81 00	-do-	100 μ F/16V	"	
C617 C618	42 00 00 FJ 23 81 00	-do-	100 μ F/16V	"	
C623 C624	42 00 00 FJ 23 81 00	-do-	100 μ F/16V	"	
C655 C656	42 00 00 FJ 24 74 70	-do-	47 μ F/25V	"	
C627 C628	42 00 00 FJ 25 71 00	-do-	10 μ F/35V	"	
C625 C626	42 00 00 FJ 26 61 00	-do-	1 μ F/50V	"	
C661 C662	42 00 00 FJ 26 61 00	-do-	1 μ F/50V	"	
R605 R606	42 00 00 HK 15 51 00	Carbon Resistor	FCR25 100 Ω	カーボン抵抗	
R627 R628	42 00 00 HK 15 51 00	-do-	100 Ω	"	
R645 R646	42 00 00 HK 15 51 50	-do-	150 Ω	"	
R665 R666	42 00 00 HK 15 51 50	-do-	150 Ω	"	
R651 R652	42 00 00 HK 15 54 70	-do-	470 Ω	"	
R655 R656	42 00 00 HK 15 54 70	-do-	470 Ω	"	
R603 R604	42 00 00 HK 15 58 20	-do-	820 Ω	"	
R625 R626	42 00 00 HK 15 58 20	-do-	820 Ω	"	
R663 R664	42 00 00 HK 15 61 00	-do-	1K Ω	"	
R649 R650	42 00 00 HK 15 61 00	-do-	1K Ω	"	
R607 R608	42 00 00 HK 15 63 30	-do-	3.3K Ω	"	
R615 R616	42 00 00 HK 15 63 30	-do-	3.3K Ω	"	
R629 R630	42 00 00 HK 15 63 30	-do-	3.3K Ω	"	
R639 R640	42 00 00 HK 15 63 30	-do-	3.3K Ω	"	
R659 R660	42 00 00 HK 15 63 30	-do-	3.3K Ω	"	
R661 R662	42 00 00 HK 15 63 90	-do-	3.9K Ω	"	
R609 R610	42 00 00 HK 15 64 70	-do-	4.7K Ω	"	
R621 R622	42 00 00 HK 15 64 70	-do-	4.7K Ω	"	
R631 R632	42 00 00 HK 15 64 70	-do-	4.7K Ω	"	
R643 R644	42 00 00 HK 15 64 70	-do-	4.7K Ω	"	
R611 R612	42 00 00 HK 15 65 60	-do-	5.6K Ω	"	
R619 R620	42 00 00 HK 15 65 60	-do-	5.6K Ω	"	
R633 R634	42 00 00 HK 15 65 60	-do-	5.6K Ω	"	
R641 R642	42 00 00 HK 15 65 60	-do-	5.6K Ω	"	
R613 R614	42 00 00 HK 15 71 00	-do-	10K Ω	"	
R617 R618	42 00 00 HK 15 71 00	-do-	10K Ω	"	
R635 R636	42 00 00 HK 15 71 00	-do-	10K Ω	"	
R647 R648	42 00 00 HK 15 71 00	-do-	10K Ω	"	
R657 R658	42 00 00 HK 15 71 00	-do-	10K Ω	"	
R668	42 00 00 HK 15 71 00	-do-	10K Ω	"	
R653 R654	42 00 00 HK 15 73 30	-do-	33K Ω	"	
R601 R602	42 00 00 HK 15 91 00	-do-	1M Ω	"	
R623 R624	42 00 00 HK 15 91 00	-do-	1M Ω	"	
R669 R670	42 00 00 HM 52 53 30	Cement Molded Resistor	MO-4R 2P 330 Ω	セメント抵抗	
VR603	42 00 00 HS 31 03 20	Variable Resistor	10K Ω	ボリューム2連	

* : New Parts

Ref. No.	Part No.	Description	(部 品 名)	Markets	Remarks
VR601 VR602	42 00 00 HS 31 03 40	-do-	20K Ω	"	
FR601 FR604	42 00 00 HW 19 43 30	Fuse Resistor J.R.A.E G.C.B	85mA 33 Ω	ヒューズ抵抗	J.R.A E,G,C,B
	42 00 00 HW 29 43 30	-do- (U)	85mA 33 Ω	"	U
FR605 FR606	42 00 00 HW 19 51 80	-do- J.R.A.E G.C.B	37mA 180 Ω	"	J.R.A.E G.C.B
	42 00 00 HW 29 51 80	-do- (U)	37mA 180 Ω	"	U
Tr 627 Tr 628	42 00 00 A 07 77 30	Transistor	2SA777	トランジスター	
Tr 603 Tr 604	42 00 00 A 09 41 00	-do-	2SA941	"	
Tr 607 Tr 608	42 00 00 A 09 41 00	-do-	2SA941	"	
Tr 611 Tr 612	42 00 00 A 09 41 00	-do-	2SA941	"	
Tr 615 Tr 616	42 00 00 A 09 41 00	-do-	2SA941	"	
Tr 617 Tr 618	42 00 00 A 09 41 00	-do-	2SA941	"	
Tr 623 Tr 624	42 00 00 A 09 41 00	-do-	2SA941	"	
Tr 631 Tr 632	42 00 00 C 15 09 30	-do-	2SC1509	"	
Tr 619 Tr 622	42 00 00 C 04 58 80	-do-	2SC458	"	
Tr 633 Tr 634	42 00 00 D 06 69 00	-do-	2SD699	"	
Tr 601 Tr 602	42 00 00 E 10 05 50	FET	2SK68A	FET	
Tr 605 Tr 606	42 00 00 E 10 05 50	-do-	2SK68A	"	
Tr 609 Tr 610	42 00 00 E 10 05 50	-do-	2SK68A	"	
Tr 613 Tr 614	42 00 00 E 10 05 50	-do-	2SK68A	"	
Tr 629 Tr 630	42 00 00 B 06 49 00	Transistor	2SB649	トランジスター	
Tr 625 Tr 626	42 00 00 C 20 88 00	-do-	2SC2088	"	
D601 D602	42 00 00 F 00 07 70	Varistor	VD1212	バリスター	
JK601	42 00 00 LB 30 08 30	Phone Jack	LJ255-1-1	ホーンジャック	
	42 00 00 LB 30 08 20	Miniature Connector Female	3P	ミニチュアコネクタコン ハウジング	
	42 00 00 LB 60 25 50	-do-	7P	"	
	42 00 00 LB 30 03 20	Miniature Connect Pin	3P	ミニチュアコネクタコンピン	
	32 00 00 RB 06 62 90	Earth Washer	\pm 8829	アースワッシャー	
	32 00 00 NA 07 15 70	Switch C.Board		スイッチシート	R,A,E,G,C,B
	32 00 00 NA 07 16 90	-do- (U)		"	U
C407 C408	42 00 00 FA 15 35 60	Mylar Capacitor	00056 μ F/50V	マイラーコン	
C405 C406	42 00 00 FA 15 41 00	-do-	001 μ F/50V	"	
C401 C404	42 00 00 FA 15 51 50	-do-	015 μ F/50V	"	
R401 R402	42 00 00 HK 15 53 90	Carbon Resistor	FCR25 390 Ω	カーボン抵抗	
R411 R412	42 00 00 HK 15 62 20	-do-	2.2K Ω	"	
R403 R404	42 00 00 HK 15 75 60	-do-	56K Ω	"	
R407 R408	42 00 00 HK 15 82 20	-do-	220K Ω	"	
R413 R416	42 00 00 HK 15 92 20	-do-	2.2M Ω	"	
R405 R406	42 00 00 HK 15 92 20	-do-	2.2M Ω	"	
SW402	42 00 00 KA 80 08 10	Push Switch	SUF2-6	プッシュSW	
SW401	42 00 00 KA 80 08 20	-do-	SUF3-6	"	
	32 00 00 NB 08 14 70	Accessories Ass'y		付属品 Ass'y	

C-4 POWER SUPPLY CIRCUITRY

